

Installation Manual

ACO - Transport connection bolted on site



- ENG** **Installation Manual**
Transport connection bolted on site
- GER** **Installationsanleitung**
Transportverbindung vorort verschraubt
- FRA** **Instructions d´installation**
Bride de liaison à boulonner sur chantier
- ESP** **Manual De Instalación**
Juntas entre canales, fijada mediante tornillos en obra
- POR** **Manual de Instalação**
Conexão transportada aparafusada no sitio
- ITA** **Manuale d´installazione**
Collegamento imbullonato in loco
- NLD** **Installatiehandleiding**
Verschroefde transportverbinding, ter plaatse te monteren
- CZE** **Instalační manuál**
Transportní spojení šroubované na stavbě
- RUS** **Инструкция По Установке**
Фланцевое соединение
- SWE** **Installationsanvisning**
Anslutningsfläns skruvas fast på plats
- NOR** **Installasjons Manual**
Kobles sammen med skruer
- FIN** **Asennusohje**
Asennustuet - ruuvattut
- DAN** **Installationsvejledning**
Transportflange boltet på stedet

- EST** **Paigaldusjuhend**
Transpordikinnitus poltkinnitusega
- LAV** **Uzstādīšanas instrukcija**
Atloka savienojumi pie uzstādīšanas
- LIT** **Montavimo instrukcija**
Transportavimo jungtis pritvirtinta varžtais
- POL** **Instrukcja montażu**
Łączenie kanałów do wykonanie na budowie poprzez skręcanie
- BUL** **Инструкции за инсталация**
Транспортна връзка, сглобена на място
- HUN** **Beépítési útmutató**
Csatlakozó karima helyszínen csavarral rögzítve
- RUM** **Instructiuni de instalare**
Imbinari fixate in suruburi la montaj
- HRV** **Upute za ugradnju**
Transportna prirubnica sa vijčanim spojem
- SLV** **Navodila za vgradnjo**
Priključki za transport vijačeni na mestu vgradnje
- SRP** **Preporuka za ugradnju**
Veza između kanala koja se vijčano povezuje na licu mesta

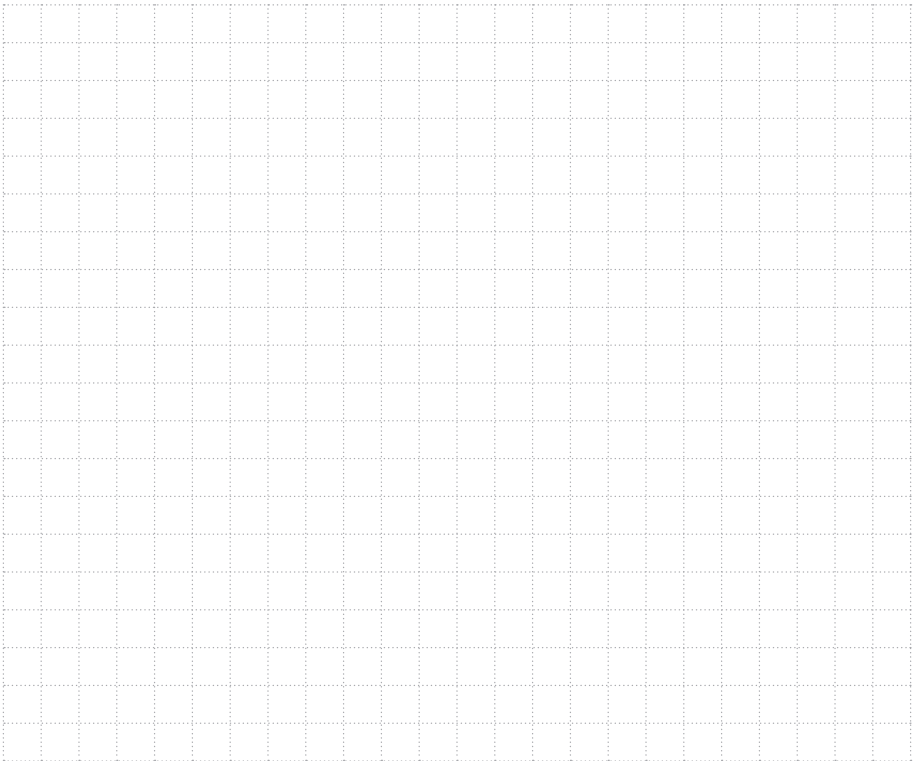
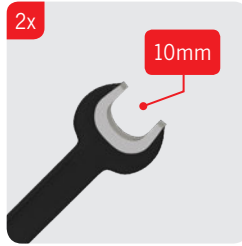

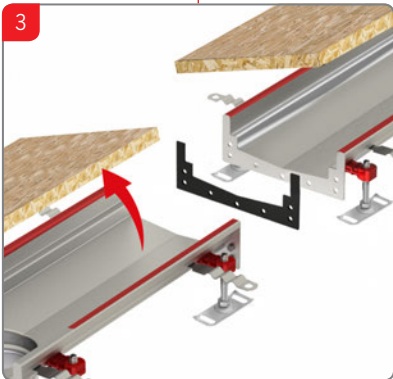

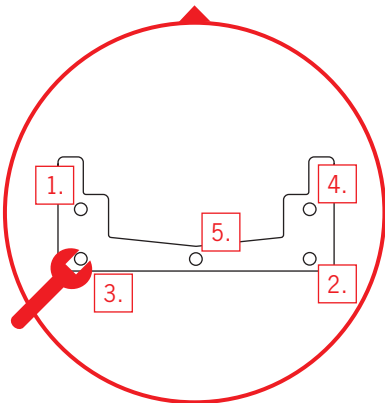
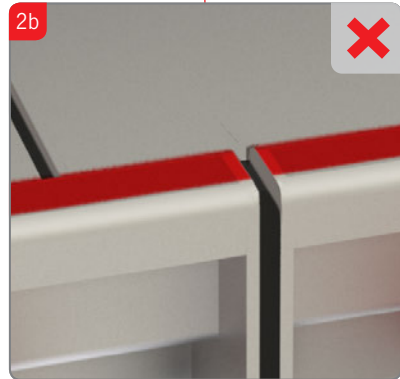
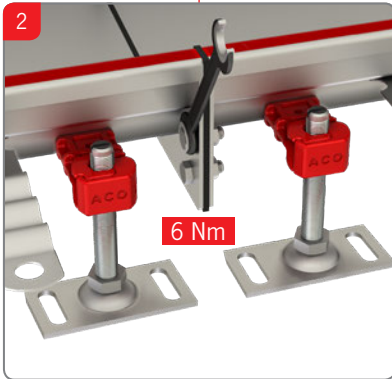
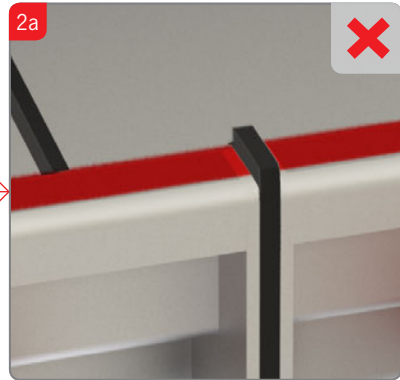



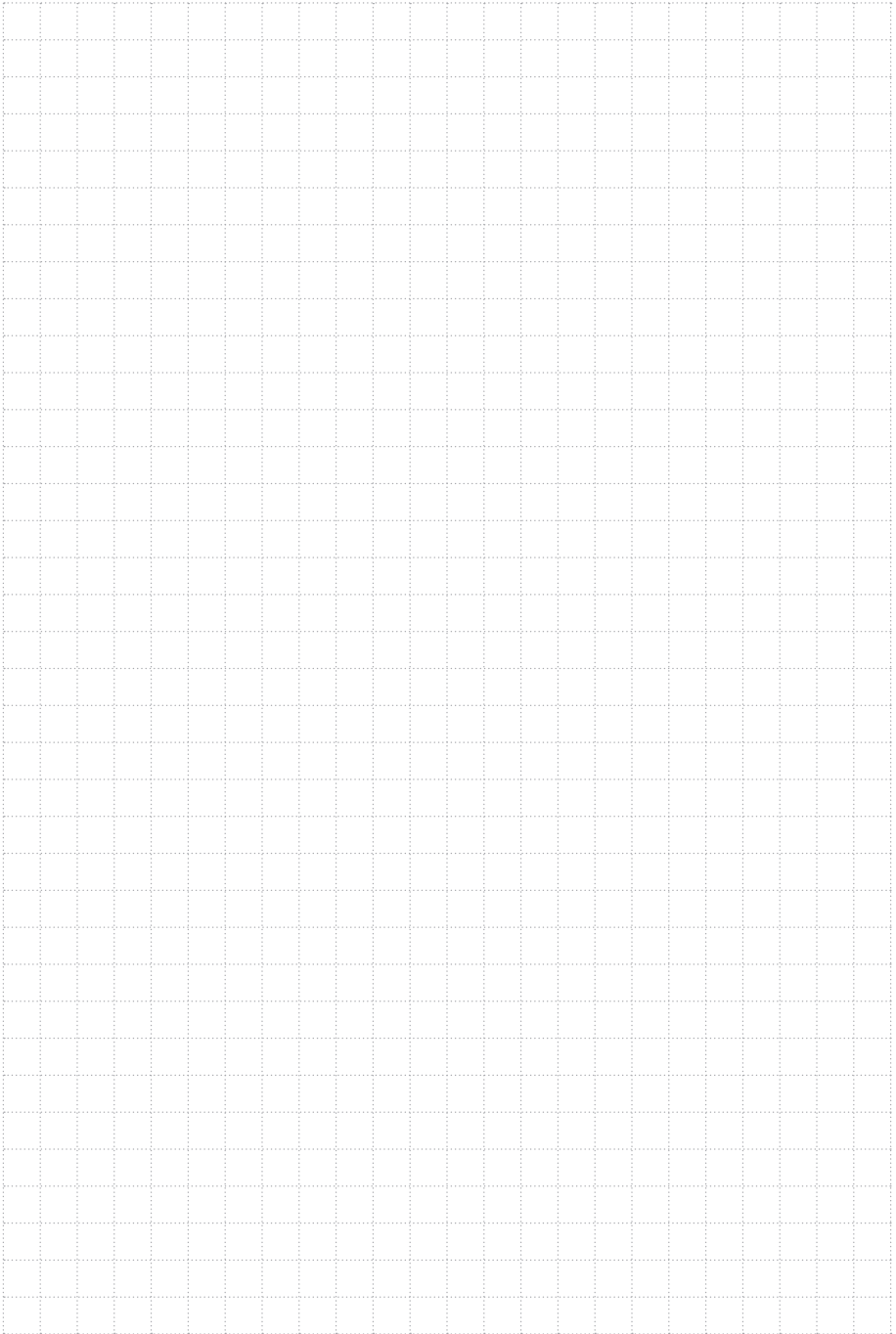

ACO. The future of drainage.

www.aco-industrialdrainage.com



NM12186 ACO - Transport connection bolted on site/KSt/EN/05/19